

MUR1602CT THRU MUR16100CT

16.0 AMP SUPER FAST RECTIFIERS

FEATURES

- * Low forward voltage drop
- * High current capability
- * High reliability
- * High surge current capability
- * Good for switching mode application

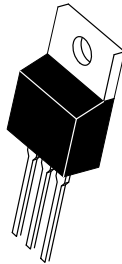

MECHANICAL DATA

- * Case: Molded plastic
- * Epoxy: UL 94V-0 rate flame retardant
- * Lead: Lead solderable per MIL-STD-202, method 208 guaranteed
- * Polarity: As Marked
- * Mounting position: Any

VOLTAGE RANGE

50 to 1000 Volts

CURRENT

16.0 Amperes

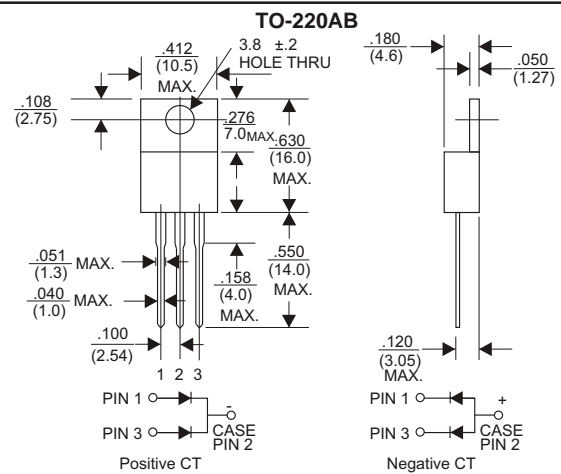

MAXIMUM RATINGS AND ELECTRICAL CHARACTERISTICS

Rating 25°C ambient temperature unless otherwise specified.
Single phase half wave, 60Hz, resistive or inductive load.
For capacitive load, derate current by 20%.

TYPE NUMBER	MUR1605CT	MUR1610CT	MUR1620CT	MUR1630CT	MUR1640CT	MUR1660CT	MUR1680CT	MUR16100CT	UNITS	
Maximum Recurrent Peak Reverse Voltage	50	100	200	300	400	600	800	1000	V	
Maximum RMS Voltage	35	70	140	210	280	420	560	700	V	
Maximum DC Blocking Voltage	50	100	200	300	400	600	800	1000	V	
Maximum Average Forward Rectified Current .375"(9.5mm) Lead Length at Ta=50°C									16.0	A
Peak Forward Surge Current, 8.3 ms single half sine-wave superimposed on rated load (JEDEC method)									200	A
Maximum Instantaneous Forward Voltage at 16.0A	1.0		1.3		1.75				V	
Maximum DC Reverse Current Ta=25°C									10	µA
at Rated DC Blocking Voltage Ta=100°C									400	µA
Maximum Reverse Recovery Time (Note 1)									50	nS
Typical Junction Capacitance (Note 2)									90	pF
Operating and Storage Temperature Range Tj, Tstg									-65 — +150	°C

NOTES:

- Reverse Recovery Time test condition: IF=0.5A, IR=1.0A, IRR=0.25A
- Measured at 1MHz and applied reverse voltage of 4.0V D.C.

RATING AND CHARACTERISTIC CURVES (MUR1605CT THRU MUR16100CT)

FIG.1- TEST CIRCUIT DIAGRAM AND REVERSE RECOVERY TIME CHARACTERISTIC

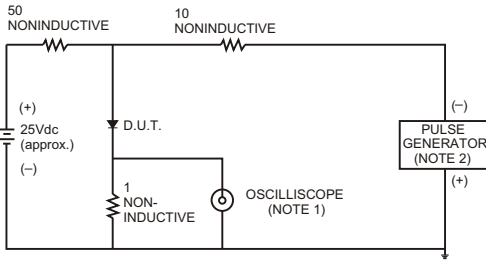

NOTES: 1. Rise Time= 7ns max., Input Impedance= 1 megohm, 22pF.
2. Rise Time= 10ns max., Source Impedance= 50 ohms.

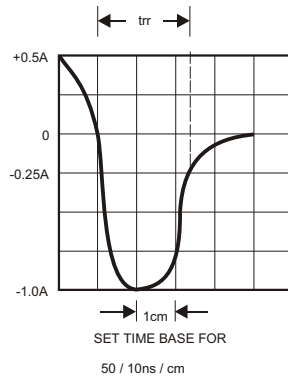

FIG.2-TYPICAL FORWARD CURRENT DERATING CURVE

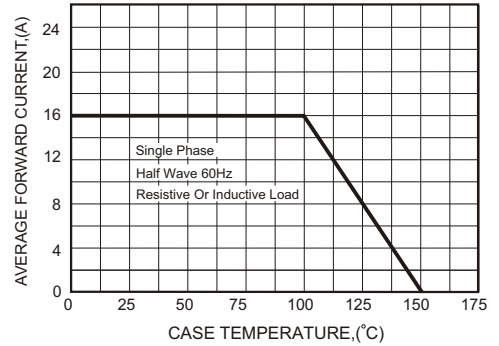

FIG.3-TYPICAL FORWARD CHARACTERISTICS

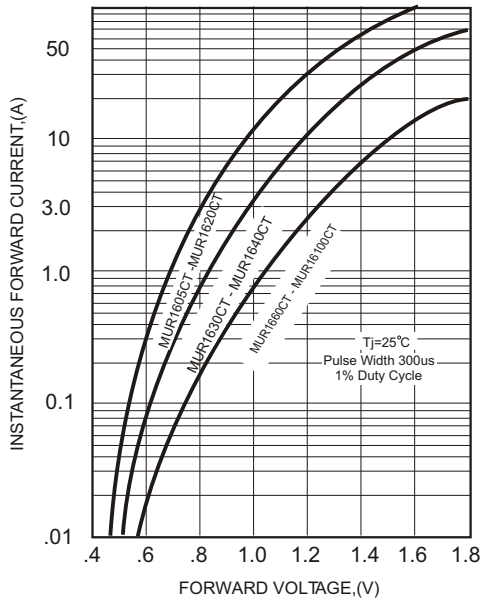

FIG.4-TYPICAL REVERSE CHARACTERISTICS

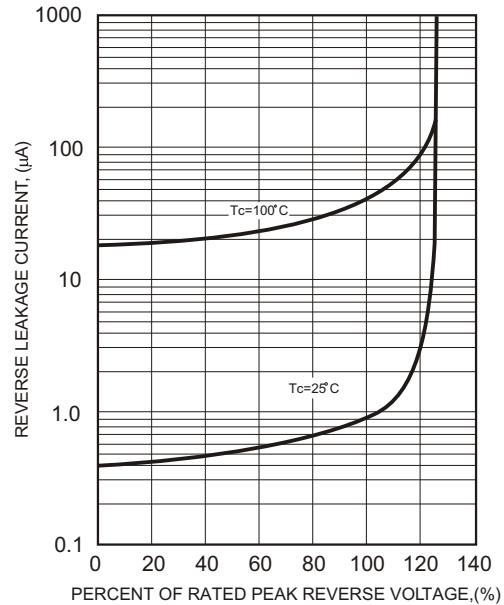

FIG.5-MAXIMUM NON-REPETITIVE FORWARD SURGE CURRENT

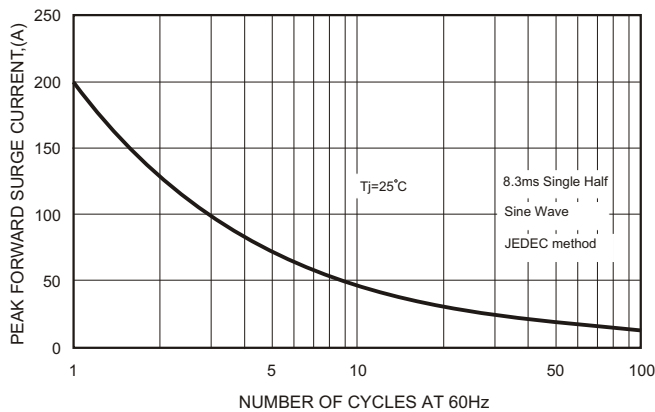

FIG.6-TYPICAL JUNCTION CAPACITANCE

